



Φ37-2027-12 Brushless DC Motor Product Datasheet

Φ37-2027-12 BLDC Overview

- Three Phase, Six Step, Full Wave, Y-Circuit
- Sintered Nd-Fe-B Permanent Magnet Rotor
- Hall Sensor / Sensorless
- Step (Cogging)
- Slot



Parameters	Φ37-2027-12 BLDC Absolute Maximum Ratings	Unit
Rotor/Bearing Broken Speed	20000	rpm
Winding and Rotor Temperature	-20 to +130	°C
Ambient Temperature	-20 to +85	°C

Notice: The Absolute Maximum Ratings are those values beyond which the safety of the device cannot be guaranteed

Parameters	Φ37-2027-12 BLDC Intrinsic Characteristics (20°C)	Unit
Resistance (Including 0.5m Line)	0.40	Ohm
Speed-Torque Gradient	38900	rpm/Nm
Torque Constant	0.013	Nm/A
Speed Constant	673	rpm/V
Back-EMF Constant	1.5	mV/rpm
Rotor Magnetic Poles	4	Poles
Ball Bearing No Load Continuous Life (At Nominal Voltage)	20000	<u>(Please order if have special requirement)</u> Hours
Weight (Including 0.5m Line)	Approximate	250 g

Φ37-2027-12 BLDC Physical Size (Unit: mm)

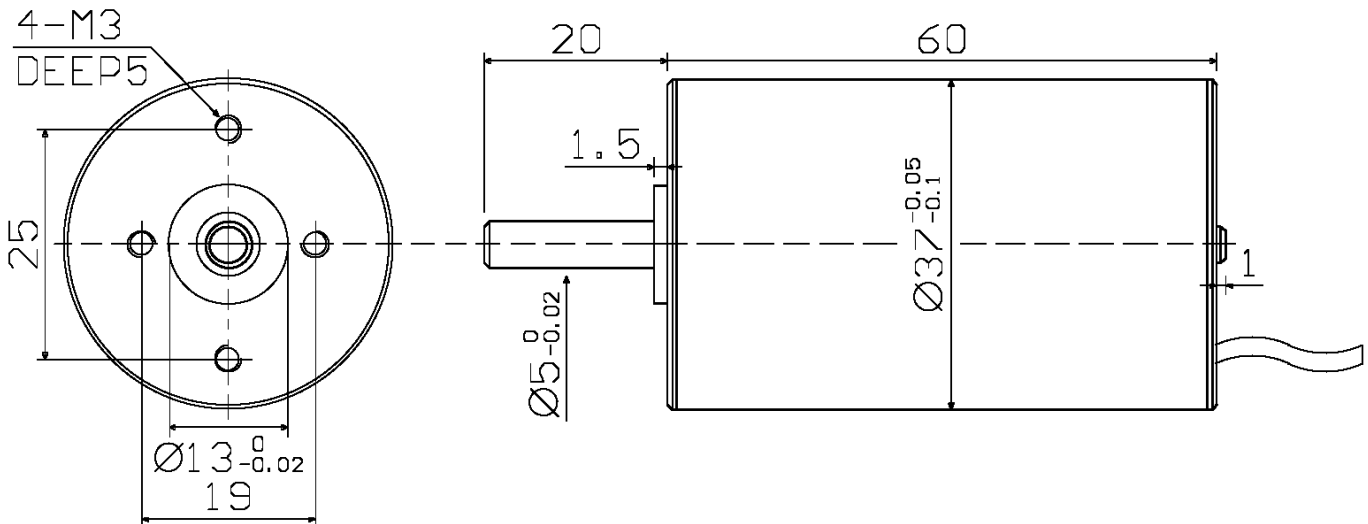



Parameters	Φ37-2027-12 BLDC Performance Characteristics (20°C)					Unit
Nominal Voltage	12					V
Maximum Output Power	44					W
(See Curves Below)	No Load Point	Some Loaded Points Performance				
Output Torque	0	0.02	0.03	0.04	0.06	Nm
Output Speed	8080	7300	6910	6520	5750	rpm
Input Current	0.31	1.81	2.55	3.30	4.79	A
Output Power	0	15	22	27	36	W
Efficiency	0	71	71	69	63	%
Free-convection Cooling	<u>If the shell temperature of the motor is higher than 85°C, fan or other cooling equipments must be installed. Otherwise the motor may be damaged by hotness.</u>					

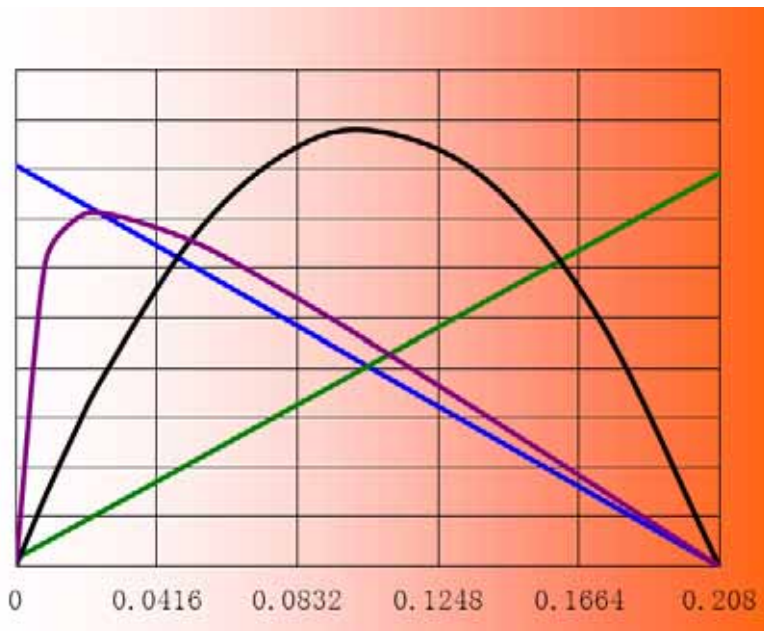

η (%) P(W) I(A) N(rpm)
 100 50 20 10000

Efficiency vs. Torque : η -----
 Output Power vs. Torque : P -----
 Current vs. Torque : I -----
 Speed vs. Torque : N -----

Short Term Operation Range:

Torque (Nm)

Φ37-2027-12 BLDC Connection Diagram and Hall Output Waveforms

- Connection: Blue thick--A phase, Yellow thick--B phase, Green thick--C phase, Blue thin--A hall, Yellow thin--B hall, Green thin--C hall, Red thin--Hall power supply, Black thin--Hall GND
- Hall Supply Voltage: 4.5 to 16VDC Regulated Supply
- Hall Power Supply Current: Less than 30mA
- Hall Output: Open collector. Require external pull-up resistors for proper logical operation. Maximum output voltage is 16V
- Electrical Hall Sensor Phasing: 120°
- Line Length: 0.5m, (Please order if have special requirement)

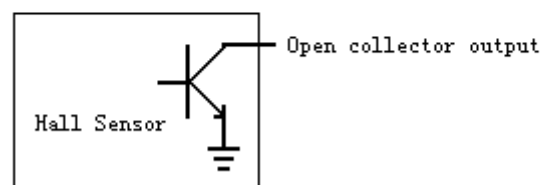
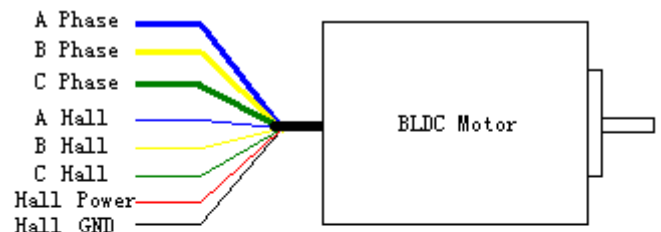

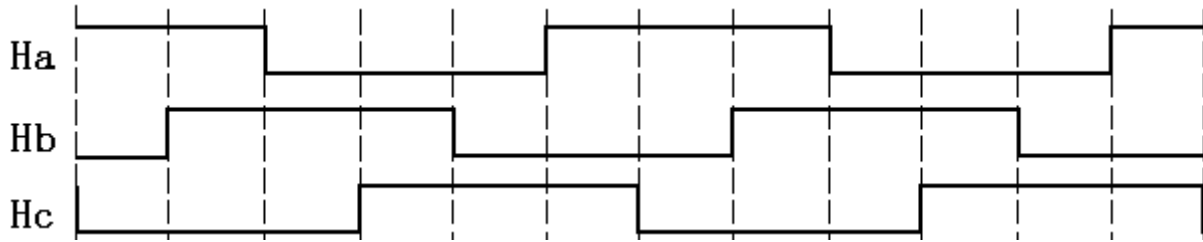

Hall Sensor Output Commutation Waveforms

Notice: The A, B, C three windings and Ha, Hb, Hc three hall sensors must be connected correctly, otherwise the controller and motor may be damaged.

Eletechnic BLDC Motor Product Code Regulation

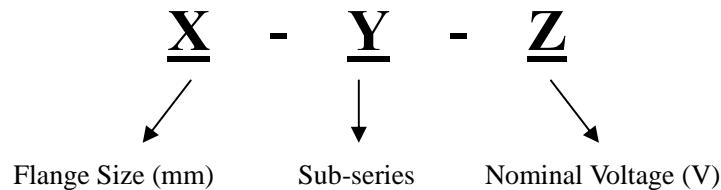

is registered trademark of Beijing Eletechnic Ltd. Eletechnic reserves the right to make changes without further notice to any products herein. Eletechnic makes no warranty, representation or guarantee regarding the suitability of its products for any particular purpose, nor does Eletechnic assume any liability arising out of the application or use of any product or circuit, and specifically disclaims any and all liability, including without limitation consequential or incidental damages. All parameters which may be provided in Eletechnic data sheets and/or specifications can and do vary in different applications and actual performance may vary over time. All operating parameters must be validated for each customer application by customer's technical experts. Eletechnic does not convey any license under its patent rights nor the rights of others. Eletechnic products are not designed, intended, or authorized for use as components in systems intended for surgical implant into the body, or other applications intended to support or sustain life, or for any other application in which the failure of the Eletechnic product could create a situation where personal injury or death may occur. Should Buyer purchase or use Eletechnic products for any such unintended or unauthorized application, Buyer shall indemnify and hold Eletechnic and its officers, employees, subsidiaries, affiliates, and distributors harmless against all claims, costs, damages, and expenses, and reasonable attorney fees arising out of, directly or indirectly, any claim of personal injury or death associated with such unintended or unauthorized use, even if such claim alleges that Eletechnic was negligent regarding the design or manufacture of the part.

How to reach us:

Address:

Chang Ping Qu, Er Bo Zi Gong Ye Yuan, Bei Qu Zhong Lu No.7

Beijing, 102208

P. R. China

Tel: 0086-10-68422061

Fax: 0086-10-68422061

EMAIL: SALES@ELETECHNIC.COM

[HTTP://WWW.ELETECHNIC.COM](http://WWW.ELETECHNIC.COM)

Beijing Eletechnic Ltd. Product Datasheet

<http://www.eletechnic.com>

Page 3

