



ARC28-38-2 Brushless DC Motor for RC Product Datasheet

ARC28-38-2 BLDC Motor Overview

- Three Phase, Six Step, Full Wave
- Y-Winding
- Sintered Nd-Fe-B Permanent Magnet Rotor
- Sensorless



Parameter	ARC28-38-2 BLDC Motor Absolute Maximum Ratings	Unit
Current	45 (Less than 10 seconds)	A
Speed	55,000	rpm
Winding and Rotor Temperature	-20 to +150	°C

Notice: The Absolute Maximum Ratings are those values beyond which the safety of the device cannot be guaranteed.

Parameter	ARC28-38-2 BLDC Motor Recommended Operating Conditions	Unit
Voltage	12	V
No Load Current	1.4	A
No Load Speed	43,000	rpm
Rated Output Power	300	W
Rated Current	35	A
Rated Speed	30,000	rpm
Speed Constant (Kv)	3,580	rpm/V
Weight (Including bullet plugs)	82	g

IMPORTANT NOTICE: Please keep the cooling holes unblocked and air blast cooling.

ARC28-38-2 BLDC Motor Size (Unit: mm)

All of the shells are made from aluminum alloys.

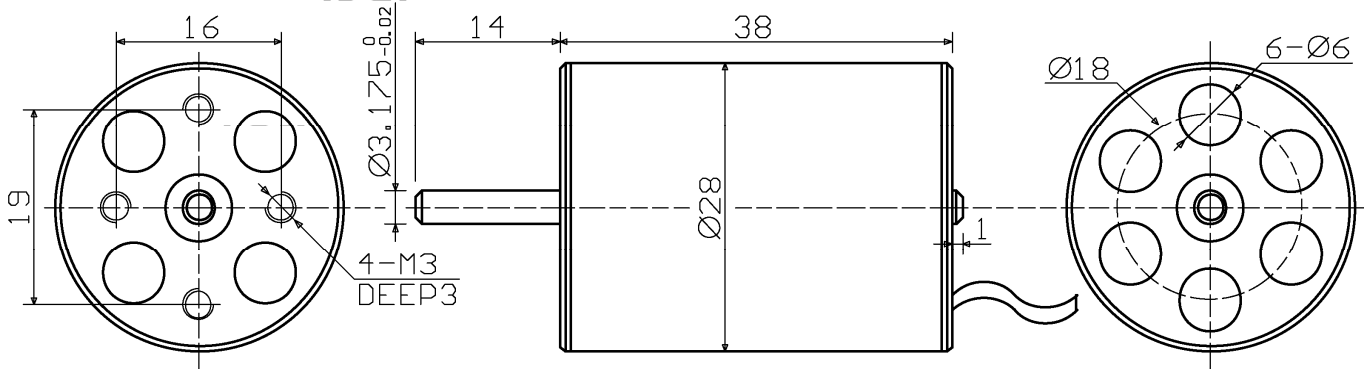



ARC28-38-2 BLDC Motor Connection Diagram

- The running direction depends on the connection sequence of three phase lines. Exchanging any two lines of the three will cause the motor to run in the opposite direction.
- Line Length: 50mm, Φ3.5 bullet plugs (Male).

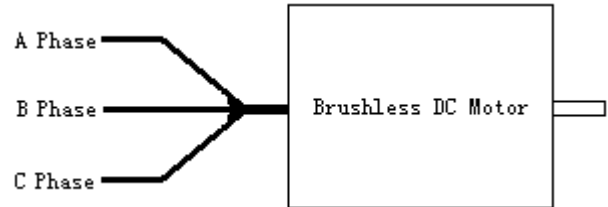

Eletechnic Brushless DC Motor for RC Product Code Regulation

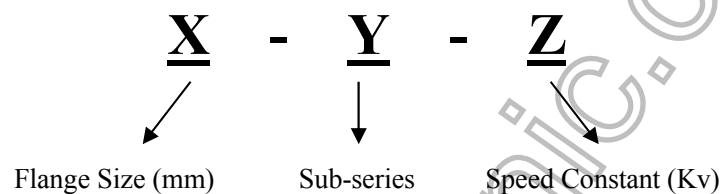

is registered trademark of Beijing Eletechnic Ltd. Eletechnic reserves the right to make changes without further notice to any products herein. Eletechnic makes no warranty, representation or guarantee regarding the suitability of its products for any particular purpose, nor does Eletechnic assume any liability arising out of the application or use of any product or circuit, and specifically disclaims any and all liability, including without limitation consequential or incidental damages. All parameters which may be provided in Eletechnic data sheets and/or specifications can and do vary in different applications and actual performance may vary over time. All operating parameters must be validated for each customer application by customer's technical experts. Eletechnic does not convey any license under its patent rights nor the rights of others. Eletechnic products are not designed, intended, or authorized for use as components in systems intended for surgical implant into the body, or other applications intended to support or sustain life, or for any other application in which the failure of the Eletechnic product could create a situation where personal injury or death may occur. Should Buyer purchase or use Eletechnic products for any such unintended or unauthorized application, Buyer shall indemnify and hold Eletechnic and its officers, employees, subsidiaries, affiliates, and distributors harmless against all claims, costs, damages, and expenses, and reasonable attorney fees arising out of, directly or indirectly, any claim of personal injury or death associated with such unintended or unauthorized use, even if such claim alleges that Eletechnic was negligent regarding the design or manufacture of the part.

How to reach us:

Address:

Chang Ping Qu, Er Bo Zi Gong Ye Yuan, Bei Qu Zhong Lu No.7

Beijing, 102208

P. R. China

Tel: 0086-10-68422061

Fax: 0086-10-68422061

EMAIL: SALES@ELETECHNIC.COM

[HTTP://WWW.ELETECHNIC.COM](http://WWW.ELETECHNIC.COM)

Beijing Eletechnic Ltd. Product Datasheet

<http://www.eletechnic.com>

Page 2

