



BLMD-8TC39-1P-S14 High Voltage Brushless DC Motor Driver

Product Datasheet

BLMD-8TC39-1P-S14 is a high voltage, three phase, full wave and hall sensor Brushless DC Motor Driver. This driver has two sub-types, AC type and DC type. AC type is suitable for 75-275VAC, 50/60Hz, one phase power supply. And DC type is suitable for 55-390VDC power supply. Rated output current of the three phases is 8ADC.

- Internal AC to DC Rectifier and Filter (Only for AC type)
- Three Phase IGBTs H-Bridge (20kHz PWM)
- Hall Sensor Electrical Phasing 120°/240°
- Reference Voltage for Hall Sensors--Vhall
- Speed Frequency Generator--FG
- Forward/Reverse Direction--F/R
- Run Enable/Disable--En
- Open Loop Stepless Speed Control--ADJ
- System Malfunction Fault Output--FLT
- Dynamic Braking--BRK (Conditional)
- Over Temperature Lockout and Unlock--OT
- Motor Line Current Feedback--CFB
- Sink Temperature Feedback--TFB
- Current Limit
- Undervoltage Lockout

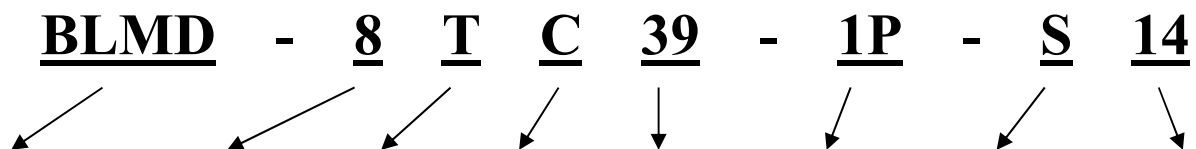

<u>Brushless</u> <u>Motor Driver</u>	<u>Rated Output:</u> 8ADC	<u>Temperature</u> <u>Lockout</u>	<u>Current</u> <u>Limit</u>	<u>Max Input:</u> 390VDC	<u>One Phase</u> <u>Protection</u>	<u>S: Sensor</u> <u>SL: Sensorless</u>	<u>Sub-series</u>
---	------------------------------	--------------------------------------	--------------------------------	-----------------------------	---------------------------------------	---	-------------------

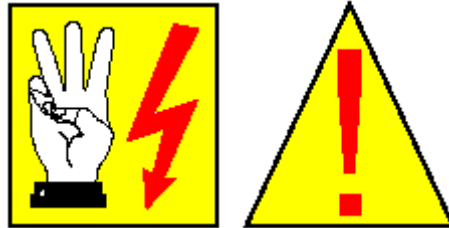

Please read Safety Warning below carefully before installing and operating this driver!

- **This product should be installed and serviced by a qualified technician, electrician, or electrical maintenance person familiar with its operation and the hazards involved.**
- **Proper installation, which includes wiring, mounting in proper enclosure, fusing, cooling, and grounding can reduce the chance of electrical shocks, fires, or explosion in this product or products used with this product, such as motors, coils, hall sensors, junctions and/or other circuits connected to it.**
- **Be sure to eliminate body static electricity when operation.**
- **To connect or disconnect J3 or J4 when power on is FORBIDDEN. J3 or J4 phase missing is FORBIDDEN.**
- **Do not touch the PCB board, and/or other circuits connected to it, when power on. Eye protection must be worn and insulated tools must be used when working under power.**
- **All output and input terminals are NOT isolated from the incoming AC mains supply and may be at up to 400V with respect to earth, regardless of the input mains supply voltage applied. These terminals are live during connection. Do not attempt to access these terminals during this time.**



Absolute Maximum Ratings

(The Absolute Maximum Ratings are those values beyond which the safety of the driver cannot be guaranteed)

Parameter	Symbol	Value	Unit
Power Supply Voltage	V _{J1}	390 (275rms)	V
Peak Output Current	I _A , I _B , I _C	22 peak (Approximate)	ADC
Rated Output Current	I _A , I _B , I _C	8	ADC
Min Permissible Inductance of Motor	L _{Motor}	1 (Line to Line)	mH
Max Controllable Motor Speed	One Magnetic Pole-pair Rotor	40000	rpm
Hall Reference Voltage Output Current	I _{Hall}	20	mA
Digital Inputs Voltage	Ha, Hb, Hc, F/R, EN, BRK, OT	-0.3 to 6.5	V
FG, FLT, OT Output Voltage	FG, FLT, OT	-0.3 to 6.5	V
FG, FLT, OT Output Current	I _{FG} , I _{FLT} , I _{OT}	5 (Sink Only)	mA
Speed Control Input Voltage	ADJ	-0.3 to 6.5	V
CFB, TFB Output Current	I _{CFB} , I _{TFB}	5 (Source and Sink)	mA
Operating Ambient Temperature Range	T _a	-20 to +85	C

Electrical Characteristics

(J1=220VAC/310VDC, T_a=20C, unless otherwise noted)

Parameter	Symbol	Min	Typical	Max	Unit
-----------	--------	-----	---------	-----	------

J1--Power Supply

AC 50/60Hz, 1 Phase	VAC	75	110/220	275	VAC
DC	VDC	55	155/310	390	VDC

V_{hall}--Reference Voltage for Hall Sensors

Output Volt	V _{hall}	-	5.2	-	VDC
Output Current	I _{hall}	-	-	20	mA

Ha, Hb, Hc--Hall Digital Inputs

High Threshold Volt	V _{IH}	3.0	2.2	-	V
Low Threshold Volt	V _{IL}	-	1.7	0.8	V
High State Current	I _{IH}	-	0	-	mA
Low State Current	I _{IL}	-	-5	-	mA

FG--Speed Frequency Generator Digital Output

High State Volt	V _{OH}	-	5.2	-	V
Low State Volt	V _{OL}	-	0.8	-	V
Source Current	I _{OH}	-1	0	-	mA
Sink Current	I _{OL}	-	-	5	mA



F/R, EN, BRK--Digital Inputs

High Threshold Volt	V _{IH}	3.0	2.2	-	V
Low Threshold Volt	V _{IL}	-	1.7	0.8	V
High State Current	I _{IH}	-75	-	-10	uA
Low State Current	I _{IL}	-300	-	-10	uA

ADJ--Open Loop Stepless Speed Control Analog Input

100% PWM	V _{UP}	-	4.2	4.5	V
0% PWM	V _{DN}	1.2	1.5	-	V

FLT--System Malfunction Digital Output

High State Volt	V _{OH}	-	3	-	V
Low State Volt	V _{OL}	-	1	-	V
Source Current	I _{OH}	-1	0	-	mA
Sink Current	I _{OL}	-	-	5	mA

OT--Over Temperature Lockout Digital Output/Unlock Digital Input

High State Volt	V _{OH}	-	-	6.2	V
Low State Volt	V _{OL}	-	0.8	-	V
Source Current	I _{OH}	-	-1	-	mA
Sink Current	I _{OL}	-	-	5	mA
Unlock Input Volt	V _{UnLock}	-	3	-	V

CFB--Motor Line Current Feedback Analog Output

Output Volt Range	V _{CFB}	0	-	6.2	V
Output Current	I _{CFB}	-	-	5	mA
Coefficient	K _{CFB}	0V=0ADC	2ADC/1V	6.2V=12.4ADC	ADC/V

TFB--Sink Temperature Feedback Analog Output

Output Volt Range	V _{TFB}	0	-	6.2	V
Output Current	I _{TFB}	-	-	5	mA

Temperature Range of Lockout/Auto Unlock

Lockout	T _s	80	85	90	C
Auto Unlock	T _s	70	75	80	C

Current Limit

Peak Current	I _A , I _B , I _C	-	22	-	ADC
Average Current	I _A , I _B , I _C	-	8 (Approx.)	-	ADC

Undervoltage Lockout

AC Supply	UV	-	30	-	VAC
DC Supply	UV	-	40	-	VDC



Junction Table

Junction	Pin	Type	Function
J1	L(+)	Power Supply	AC Live Line, DC Positive
	N(-)	Power Supply	AC Null line, DC Negative
	To Earth	-	Earth Line
J2	FG	Digital Output	Speed Frequency Generator, TTL Compatible
	F/R	Digital Input	Forward/Reverse Direction, TTL Compatible
	EN	Digital Input	Run Enable/Disenable, TTL Compatible
	UP	Voltage Divider	Potentiometer Up Pin
	ADJ	Analog Input	Open Loop Stepless Speed Control
	DN	Voltage Divider	Potentiometer Down Pin
	FLT	Digital Output	System Malfunction Output, TTL Compatible
	BRK	Digital Input	Dynamic Braking, TTL Compatible
	GND	-	Signals GND
	OT	Digital I/O	Over Temperature Lockout and Unlock, TTL Compatible
	CFB	Analog Output	Motor Line Current Feedback
TFB	Analog Output	Sink Temperature Feedback	
J3	A	Driver Output	A Phase Winding Driver
	B	Driver Output	B Phase Winding Driver
	C	Driver Output	C Phase Winding Driver
J4	GND	-	Hall Sensors GND
	Ha	Digital Input	A Hall Sensor, TTL Compatible
	Hb	Digital Input	B Hall Sensor, TTL Compatible
	Hc	Digital Input	C Hall Sensor, TTL Compatible
	Vhall	Reference Output	Reference Voltage for Hall Sensors

Main Functions Description

J1--Power Supply:

This driver has two sub-types, AC type and DC type. AC type is suitable for 75-275VAC, 50/60Hz, 1 Phase power supply. There is a build-in rectifier and filter AC to DC converter. Its maximum load capability is about 11AAC. DC type is suitable for 55-390VDC power supply. Its maximum load capability is about 8ADC. The FUSE is 15A.

Because of the different connections of GND Lines, these two sub-types cannot be substituted for each other. Otherwise the GND Lines will be broken.

J3--A, B, C Three Phase Winding Driver:

The driver output circuit is shown in right figure. Three Phase, Full wave, H-Bridge could drive either Y or Delta winding motor. Please see "Commutation Truth Table" for details.

The use of 20kHz pulse width modulation at the three bottom IGBTs provides an energy efficient method of controlling the motor speed by varying the average voltage applied to each stator winding during the commutation sequence.

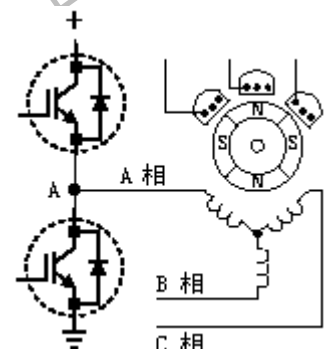



To connect or disconnect J3 when power on is FORBIDDEN! J3 phase missing is FORBIDDEN!

Vhall--Reference Voltage for Hall Sensors:

This reference power could output only 20mA for hall sensors. It is FORBIDDEN to supply any other loads!

Ha, Hb, Hc--Hall Digital Inputs:

TTL compatible. The internal circuit is shown in right figure. Please see "Commutation Truth Table" for details.

The hall sensor electrical phasing must be 120°/240°, 60°/300° is FORBIDDEN. And Ha, Hb, Hc signals must be connected correctly according to A, B, C windings. Otherwise the driver and motor may be damaged!

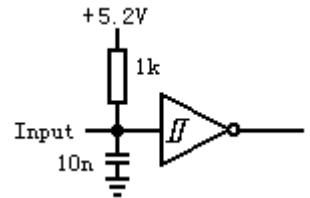

To connect or disconnect J4 when power on is FORBIDDEN! J4 phase missing is FORBIDDEN!

FG--Speed Frequency Generator Digital Output:

TTL compatible. Open collector output. The internal circuit is shown in right figure.

Its frequency is directly proportional to the motor speed. Pulse duty cycle is about 50%. The output waveforms are shown in left figure.



$FG \text{ (Hz)} = \text{Speed (rpm)} * N * 3 / 60$. N means the number of magnetic pole-pairs (NOT POLES) of the rotor.

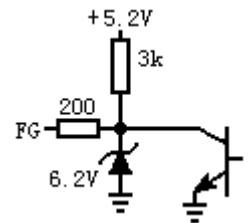

F/R--Forward/Reverse Direction Digital Input:

TTL compatible. The internal circuit is shown in right figure. Please see "Commutation Truth Table" for details.

When F/R signal is high or float, the direction of motor rotation is forward. When F/R is low, it is reverse. The running direction also depends on the structure of BLDC motor.

JFR switch could change the direction on board. But when using J2-F/R pin as signal source, please set JFR OPEN. Otherwise the J2-F/R signal will be invalid.

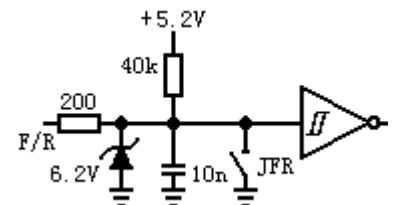

Reversing when running is FORBIDDEN! That means the motor must be disable (En=0) and speed down to quiescence first, then give F/R reverse signal, then enable (En=1) and speed up.

En--Run Enable/Disenable Digital Input:

TTL compatible. The internal circuit is shown in right figure. Please see "Commutation Truth Table" for details.

A logic high or float at En pin causes the motor to run, while a low causes motor to coast and ABC three phases output Z state.

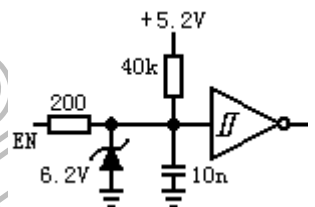

ADJ--Open Loop Stepless Speed Control Analog Input:

Analog signal. The internal circuit is shown in right figure. There are three ways to control speed: (Please see "Application Circuit Examples" for details)

First, connect the top side and bottom side of a 10kOhm potentiometer to the UP pin and DN pin of J2 separately. And connect the middle pin of the potentiometer to ADJ pin.

Second, using an operational amplifier (or D/A). Connect the output of operational amplifier (or D/A) directly to ADJ pin.

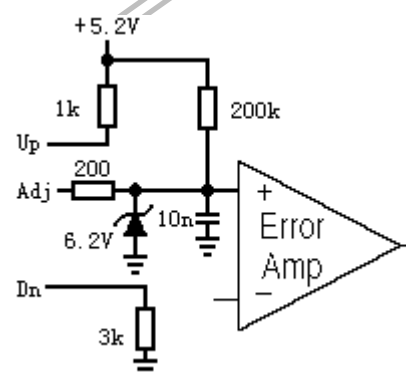



Third, connect a filtered pulse width modulation signal directly to ADJ pin. The external filter $RC > 2ms$ and $f > 10kHz$ is recommended.

When the input voltage of ADJ is lower than 1.5V, the output PWM of three phases is 0%. When the input voltage of ADJ is higher than 4.2V, the output PWM of three phases is 100%.

FLT--System Malfunction Digital Output:

TTL compatible. Open collector output. The internal circuit is shown in right figure. Please see "Commutation Truth Table" for details.

A logic high means the motor works normally. A logic low means there are something wrong and causes the FLT Led on and ABC three phases output Z state.

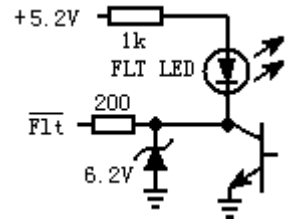

BRK--Dynamic Braking Digital Input (Conditional):

TTL compatible. The internal circuit is shown in right figure.

Using this function need high quality engineer and additional external circuits. Incorrect operation will cause over voltage, over current and other serious results. The default setting of this function is DISABLED. That means any operation on this pin is invalid. Please contact us for technical supports if you want this function, and ask for additional Appendix Datasheets.

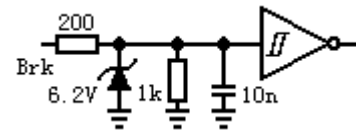

OT--Over Temperature Lockout Digital Output and Unlock Digital Input:

TTL compatible. I/O bi-direction. Open collector output. The internal circuit is shown in below figure. Please see "Commutation Truth Table" for details.

There is an over temperature protection inside the driver. 85C sink temperature causes over temperature protection active and system auto lockout. OT becomes high, ABC three phases output Z state, all junction pins invalid, OTC Led on, motor stops.

When sink temperature drops below 75C, over temperature protection is inactive. But if system could unlock depends on Unlock Mode Setting.

There are two Unlock Modes: Auto Unlock Mode and Passive Unlock Mode.

If choose Auto Unlock Mode. When sink temperature drops below 75C. System auto unlock, OT becomes low, OTC Led off and motor re-start normally.

If choose Passive Unlock Mode. Even if sink temperature drops below 75C, system will keep locking until an external negative pulse input from OT pin. The external control circuit is shown in above figure. Open collector external circuit is recommended, push-pull circuit is FORBIDDEN!

The default setting of this drive is Passive Unlock Mode.

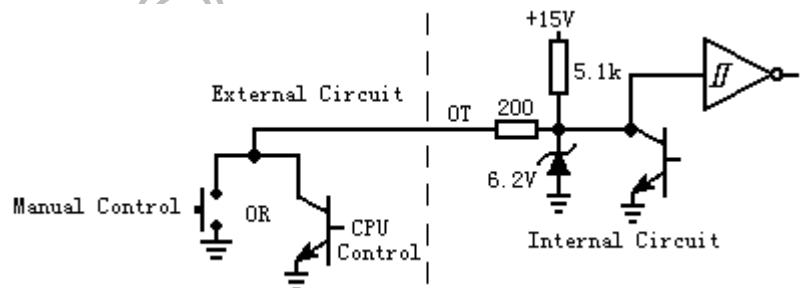

CFB--Motor Line Current Feedback Analog Output:

Analog signal. The internal circuit is shown in right figure.

This signal feeds back the line current of BLDC motor, its unit is DC Ampere. It is linear. Coefficient is about 2ADC/1V.

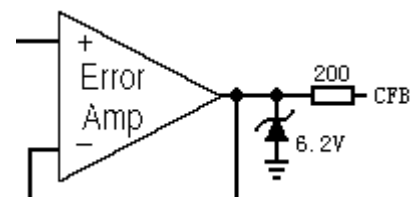



TFB--Sink Temperature Feedback Analog Output:

Analog signal. The internal circuit is shown in right figure.

This signal feeds back the temperature of the sink. It is non-linear due to the NTC. Please check below table for details.

Approximate linear formula: $T_s (C) = 85 - 10 * (4.2 - V_{TFB})$. This formula is precise enough in temperature range from 70 to 85C.

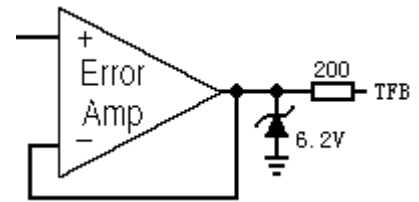

Sink Temperature	T_s	50	60	70	75	80	85	C
Output Volt	V_{TFB}	1.3	1.9	2.7	3.2	3.7	4.2	V

Current Limit:

An internal current limit circuit is inside this driver in order to protect J3 H-Bridges. 22ADC peak current limitation value is set, and average current is about 8ADC. When over current is active, OTC Led is on. Please see “Commutation Truth Table” for details.

Undervoltage Lockout:

An undervoltage lockout has been incorporated to prevent damage to the IC and the IGBTs. When power supply $AC < 30V$ or $DC < 40V$, driver turns off, and auto-restart when voltage goes up.

Commutation Truth Table (OT Mode is Auto Unlock Mode)

Hall Inputs			Control Inputs			Over Temp	Over Crnt	H-Bridge Driver			Signal Outputs		
Ha	Hb	Hc	F/R	EN	BRK			A	B	C	FLT	OT	OTC Led
X	X	X	X	X	X	Act	X	Z	Z	Z	1	1	ON
X	X	X	X	X	X	X	Act	Z	Z	Z	1	0	ON
1	1	1	X	X	0	Inact	Inact	Z	Z	Z	0	0	OFF
0	0	0	X	X	0	Inact	Inact	Z	Z	Z	0	0	OFF
1	1	1	X	X	1	Inact	Inact	0	0	0	0	0	OFF
0	0	0	X	X	1	Inact	Inact	0	0	0	0	0	OFF
Six Valid Combinations (Figure Below)			X	0	1	Inact	Inact	0	0	0	0	0	OFF
			X	0	0	Inact	Inact	Z	Z	Z	0	0	OFF
			X	1	1	Inact	Inact	0	0	0	1	0	OFF
			1/0	1	0	Inact	Inact	Normal Commutation (Figure Below)			1	0	OFF

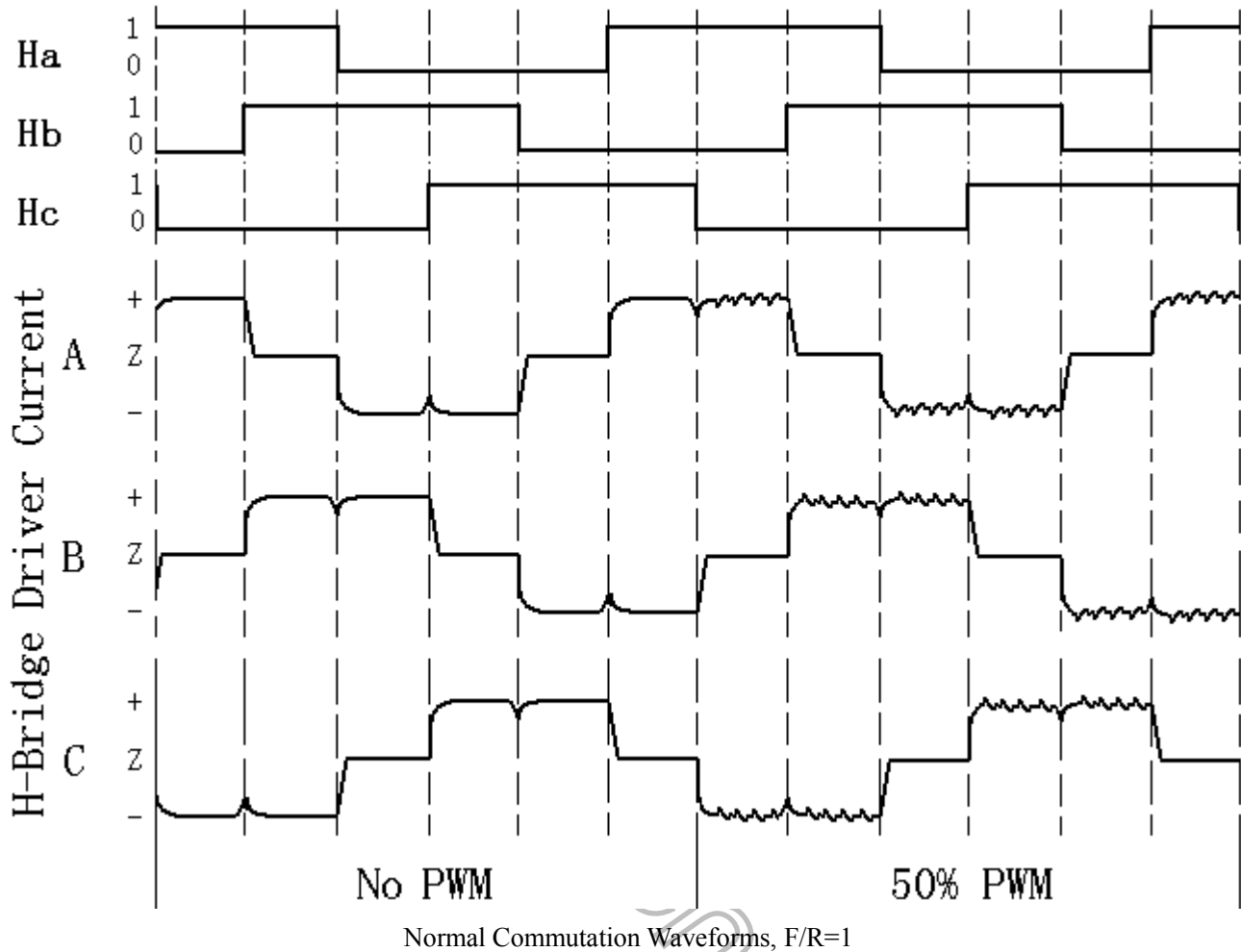

Note: "1"=High, "0"=Low, "X"=Don't care, "Z"=High impedance, "+"= Positive current, "-"=Negative current

Driver Dimension and Connection Diagram (Unit: mm)

The driver dimension is 150 (L) X 86 (W) X 78 (H). The approximate weight of the driver is 520g (including intrinsic sink).

The size of the sink can be custom-ordered according to the motor power, heating and cooling of the application.

If the surface temperature of the sink is always higher than 85C, cooling fan must be installed. Otherwise the driver would be over temperature lockout.

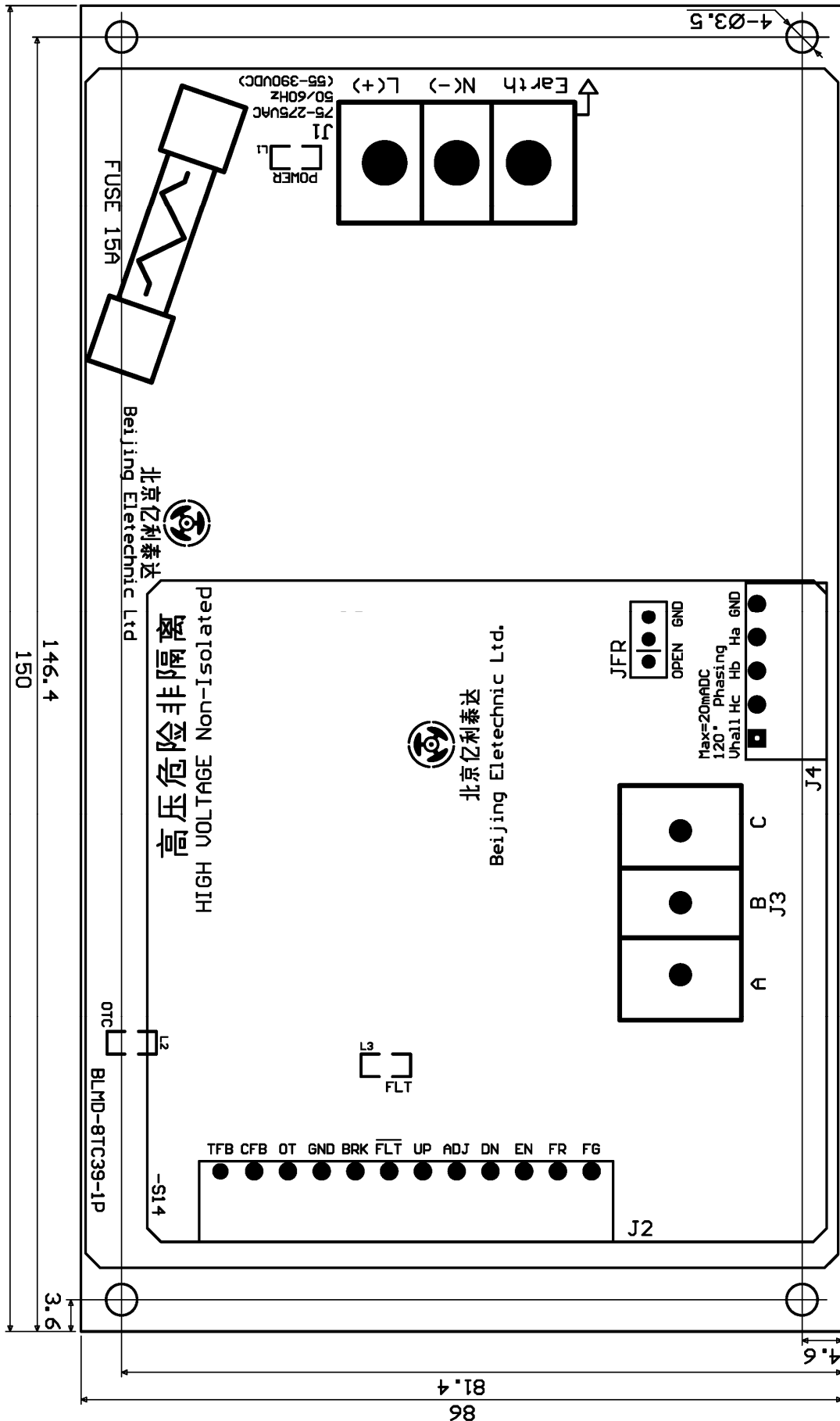



Application Circuit Examples

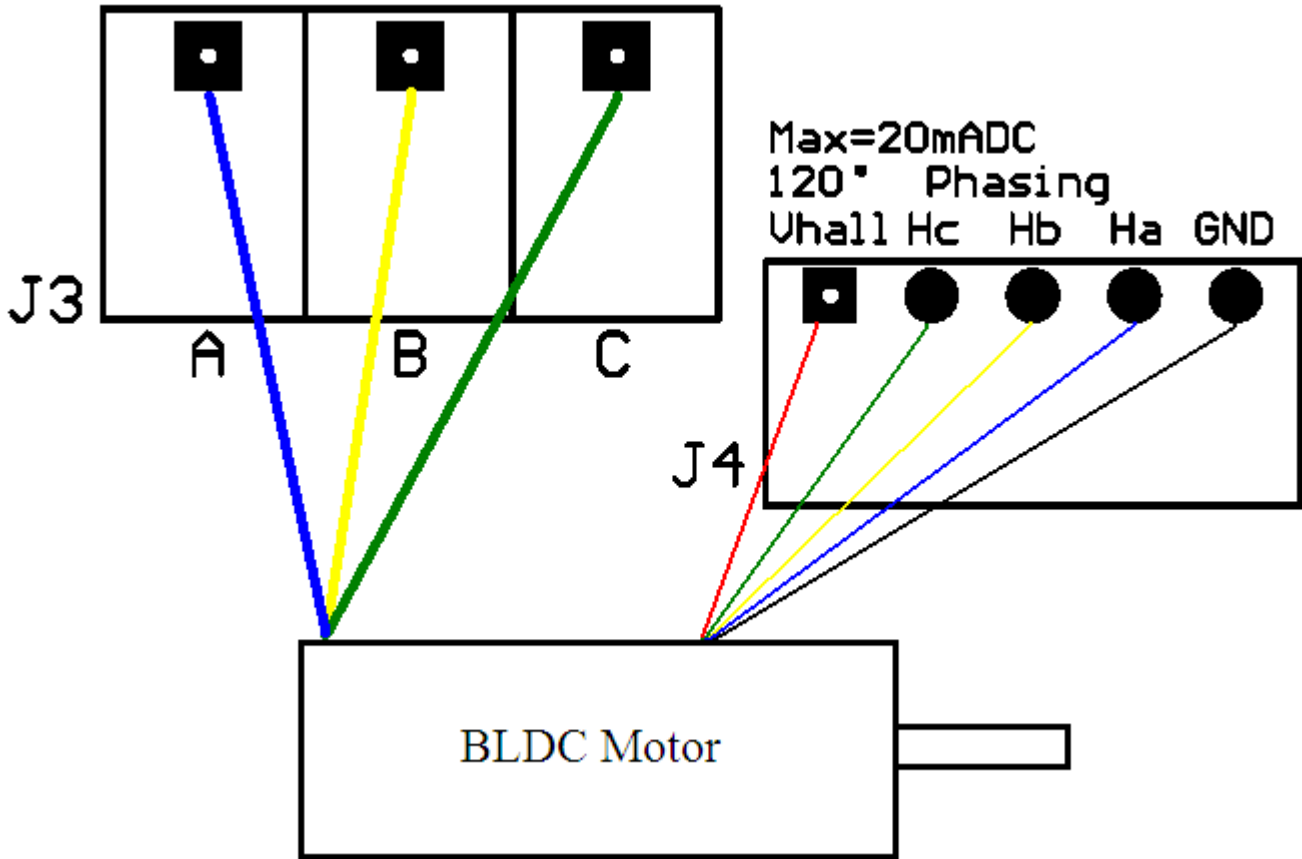

The Connection of BLDC Motor

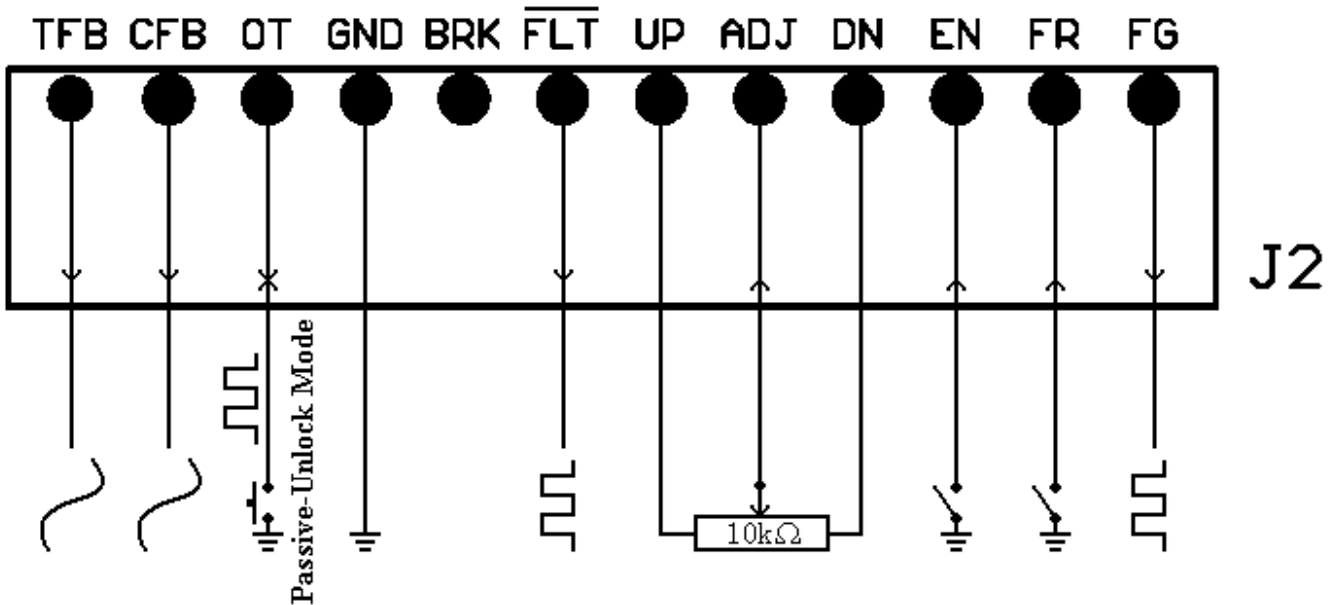

The Connection of Mechanical Switches and Potentiometer Speed Control

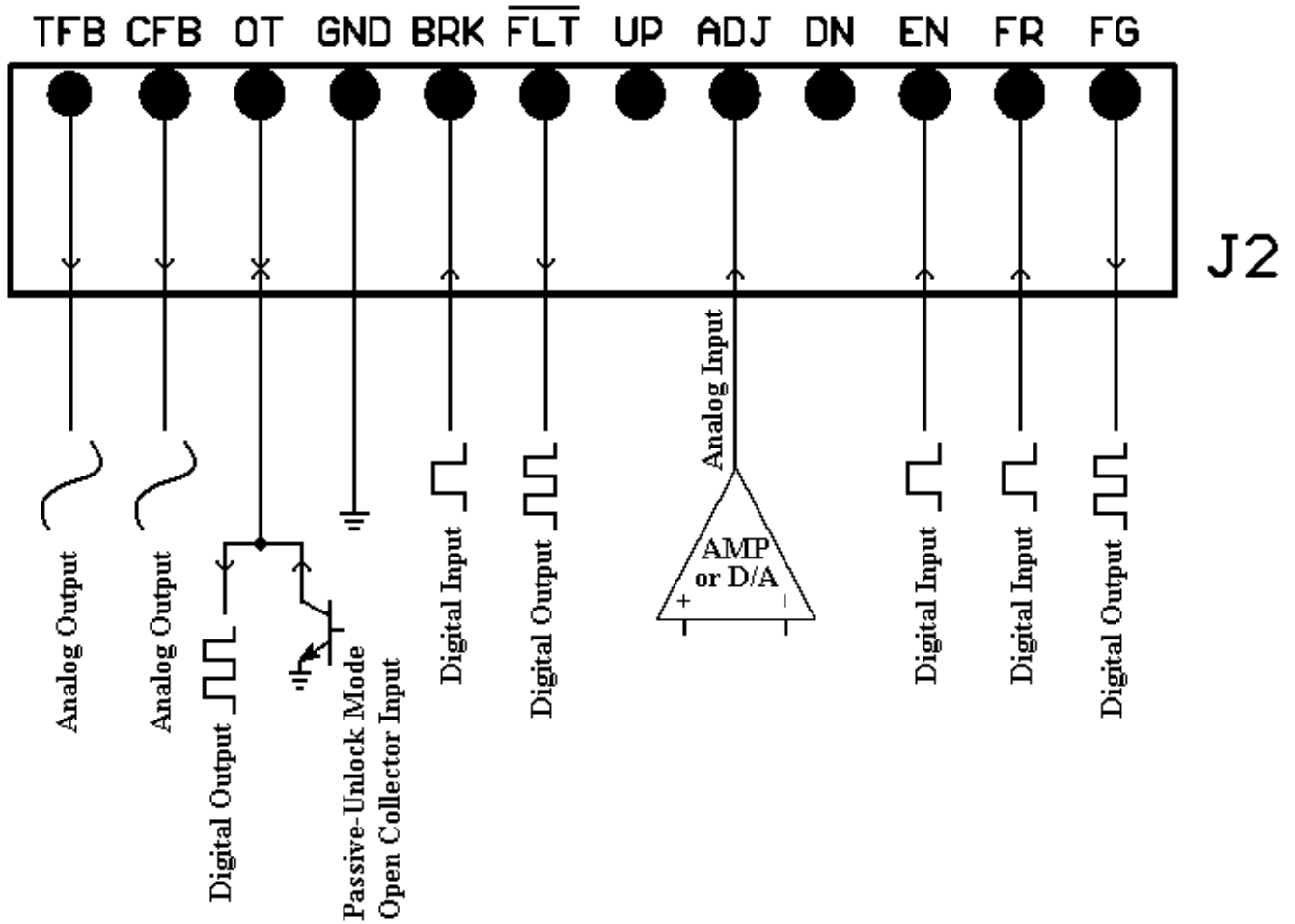

The Connection of Digital Control and Operational Amplifier (or D/A) Speed Control



is registered trademark of Beijing Eletechnic Ltd. Eletechnic reserves the right to make changes without further notice to any products herein. Eletechnic makes no warranty, representation or guarantee regarding the suitability of its products for any particular purpose, nor does Eletechnic assume any liability arising out of the application or use of any product or circuit, and specifically disclaims any and all liability, including without limitation consequential or incidental damages. All parameters which may be provided in Eletechnic data sheets and/or specifications can and do vary in different applications and actual performance may vary over time. All operating parameters must be validated for each customer application by customer's technical experts. Eletechnic does not convey any license under its patent rights nor the rights of others. Eletechnic products are not designed, intended, or authorized for use as components in systems intended for surgical implant into the body, or other applications intended to support or sustain life, or for any other application in which the failure of the Eletechnic product could create a situation where personal injury or death may occur. Should Buyer purchase or use Eletechnic products for any such unintended or unauthorized application, Buyer shall indemnify and hold Eletechnic and its officers, employees, subsidiaries, affiliates, and distributors harmless against all claims, costs, damages, and expenses, and reasonable attorney fees arising out of, directly or indirectly, any claim of personal injury or death associated with such unintended or unauthorized use, even if such claim alleges that Eletechnic was negligent regarding the design or manufacture of the part.

How to reach us:

Address:

Chang Ping Qu, Er Bo Zi Gong Ye Yuan, Bei Qu Zhong Lu No.7

Beijing, 102208

P. R. China

Tel: 0086-10-68422061

Fax: 0086-10-68422061

EMAIL: SALES@ELETECHNIC.COM

[HTTP://WWW.ELETECHNIC.COM](http://WWW.ELETECHNIC.COM)